

**STANDARD PROFILE KNIVES IN "SP" STEEL - height 50x4 mm  
(RELATING LIMITERS)**

**Example:  
Knife SA2..  
Limiter (SA3..)**

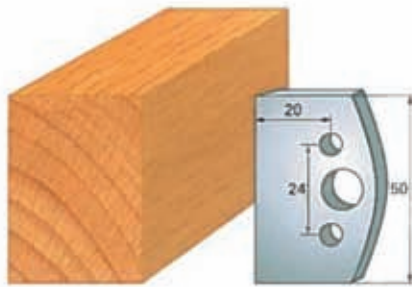

Art. SA2000 - (SA3000)

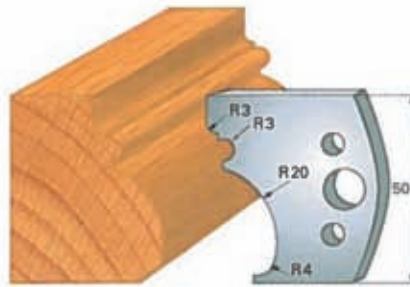

Art. SA2001 - (SA3001)



Art. SA2002 - (SA3002)

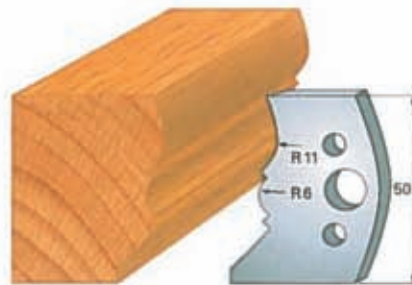

Art. SA2004 - (SA3004)

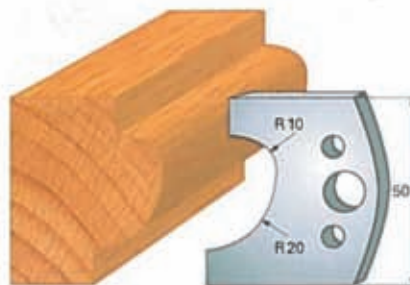

Art. SA2005 - (SA3005)

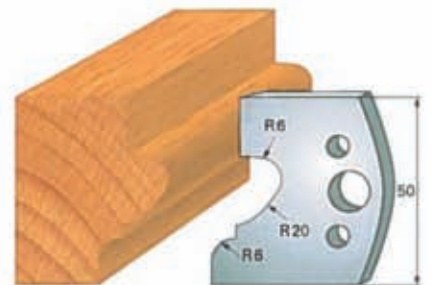

Art. SA2006 - (SA3006)

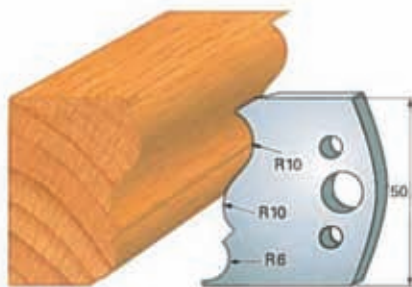

Art. SA2007 - (SA3007)

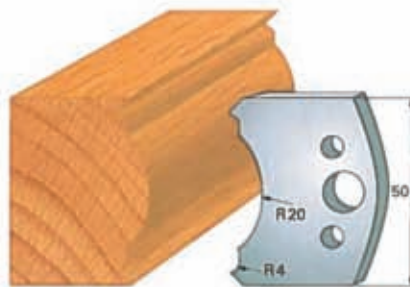

Art. SA2008 - (SA3008)

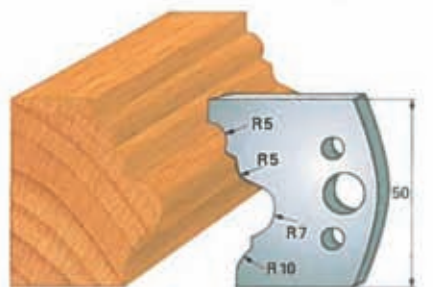

Art. SA2009 - (SA3009)

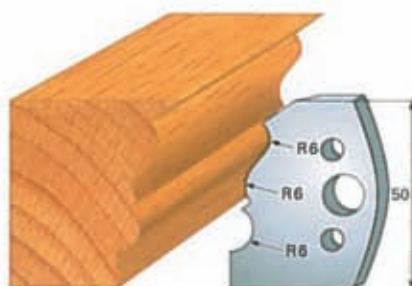

Art. SA2010 - (SA3010)

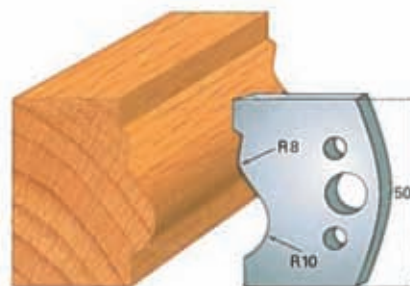

Art. SA2011 - (SA3011)

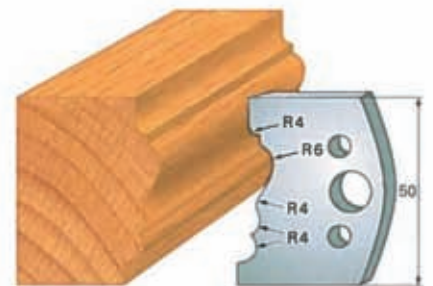

Art. SA2012 - (SA3012)

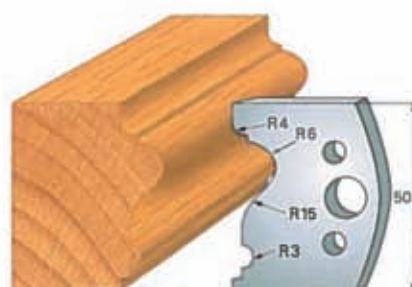

Art. SA2013 - (SA3013)

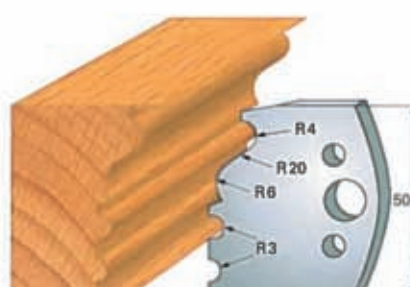

Art. SA2014 - (SA3014)

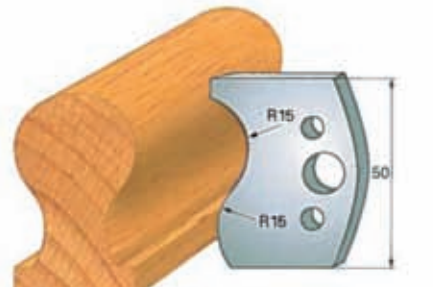

Art. SA2015 - (SA3015)

**STANDARD PROFILE KNIVES IN "SP" STEEL - height 50x4 mm  
(RELATING LIMITERS)**

**Example:  
Knife SA2..  
Limiter (SA3..)**



Art. SA2016 - (SA3016)

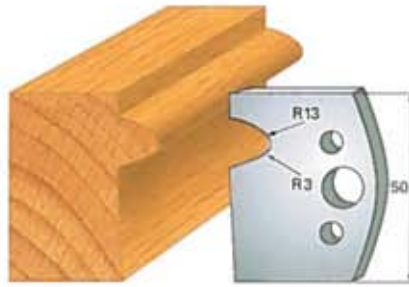

Art. SA2017 - (SA3017)

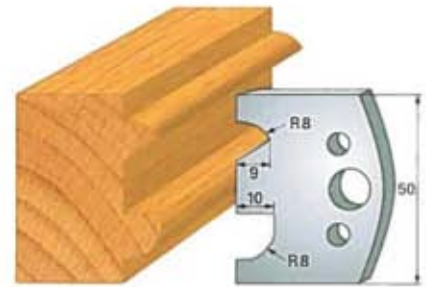

Art. SA2018 - (SA3018)

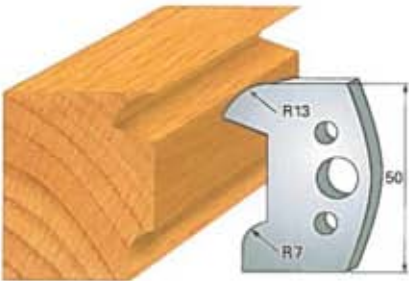

Art. SA2019 - (SA3019)

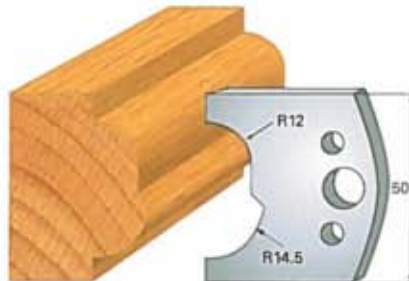

Art. SA2020 - (SA3020)

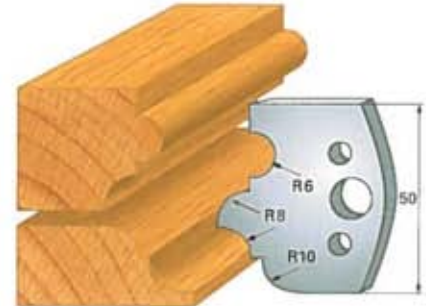

Art. SA2021 - (SA3021)

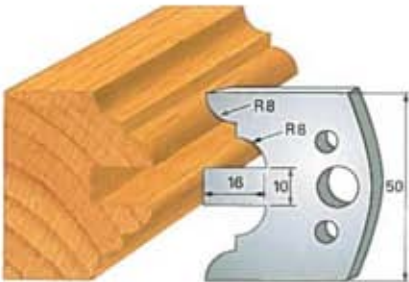

Art. SA2022 - (SA3022)

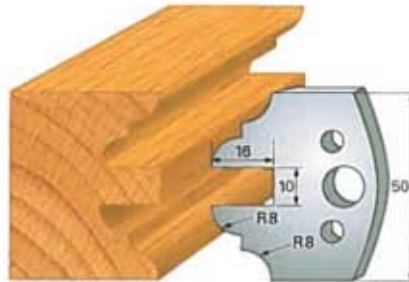

Art. SA2023 - (SA3023)



Art. SA2024 - (SA3024)



Art. SA2025 - (SA3025)

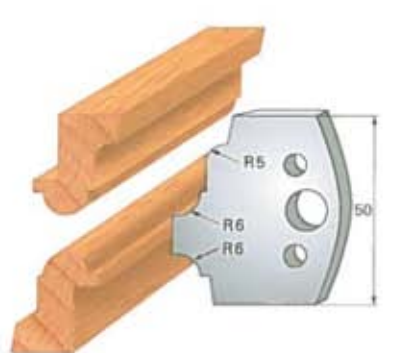

Art. SA2026 - (SA3026)



Art. SA2027 - (SA3027)



Art. SA2028 - (SA3028)



Art. SA2029 - (SA3029)

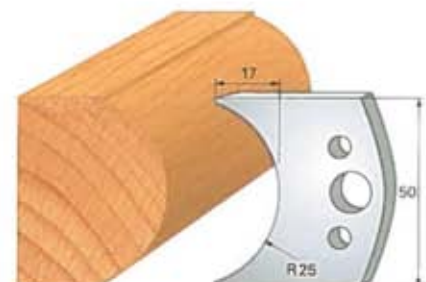

Art. SA2030 - (SA3030)

**STANDARD PROFILE KNIVES IN "SP" STEEL - height 50x4 mm  
(RELATING LIMITERS)**

**Example:  
Knife SA2.  
Limiter (SA3..)**



Art. SA2031 - (SA3031)



Art. SA2032 - (SA3032)

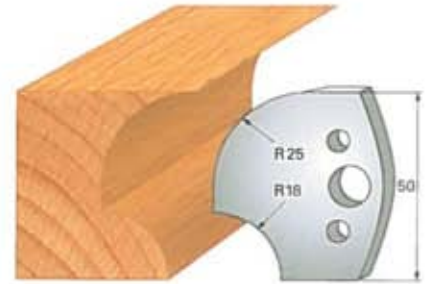

Art. SA2033 - (SA3033)



Art. SA2034 - (SA3034)

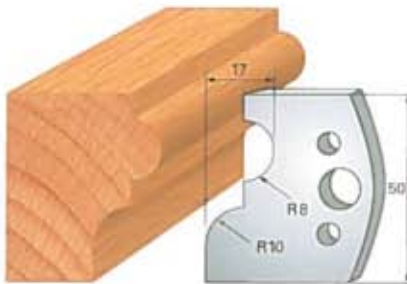

Art. SA2035 - (SA3035)



Art. SA2036 - (SA3036)



Art. SA2037 - (SA3037)



Art. SA2038 - (SA3038)



Art. SA2039 - (SA3039)



Art. SA2040 - (SA3040)

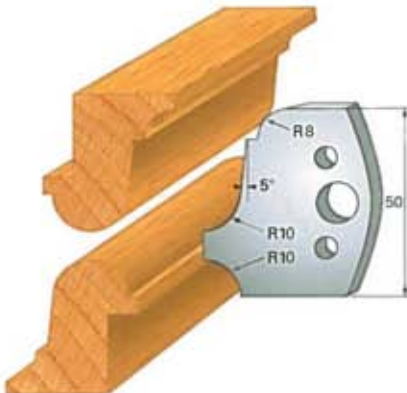

Art. SA2041 - (SA3041)

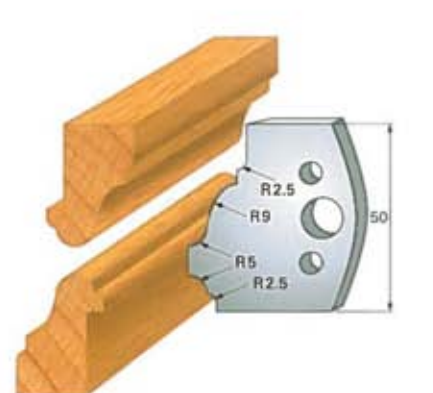

Art. SA2042 - (SA3042)



Art. SA2043 - (SA3043)



Art. SA2044 - (SA3044)



Art. SA2045 - (SA3045)

**STANDARD PROFILE KNIVES IN "SP" STEEL - height 50x4 mm  
(RELATING LIMITERS)**

**Example:  
Knife SA2..  
Limiter (SA3..)**

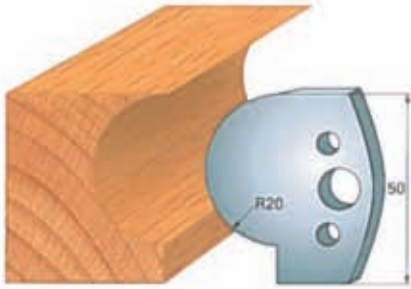

Art. SA2046 - (SA3046)



Art. SA2047 - (SA3047)



Art. SA2048 - (SA3048)

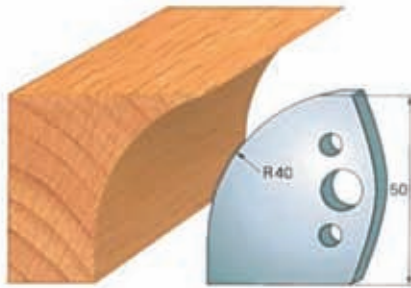

Art. SA2049 - (SA3049)

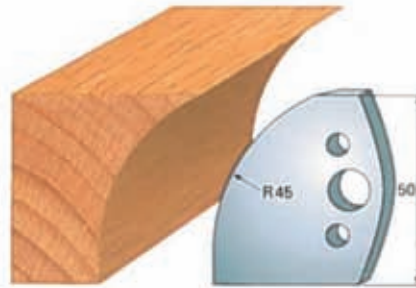

Art. SA2050 - (SA3050)



Art. SA2051 - (SA3051)

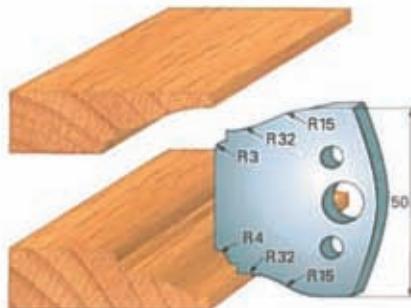

Art. SA2052 - (SA3052)

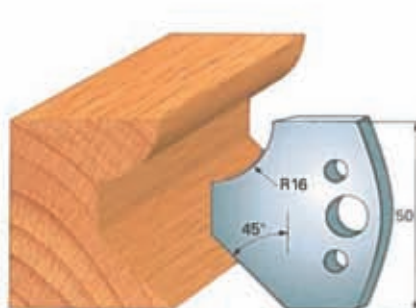

Art. SA2053 - (SA3053)

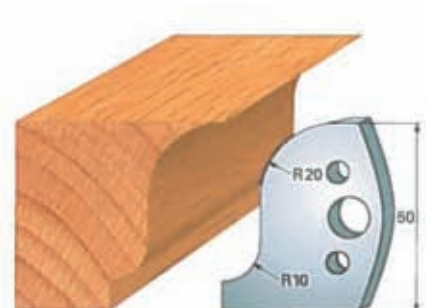

Art. SA2054 - (SA3054)



Art. SA2055 - (SA3055)

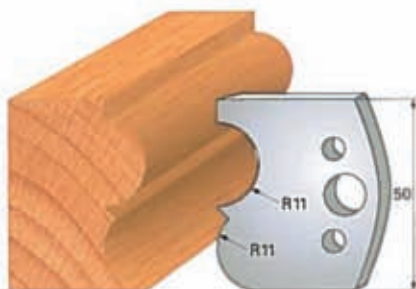

Art. SA2056 - (SA3056)



Art. SA2057 - (SA3057)



Art. SA2058 - (SA3058)

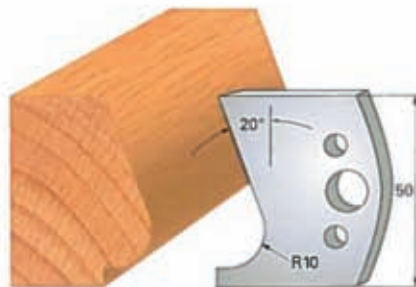

Art. SA2059 - (SA3059)

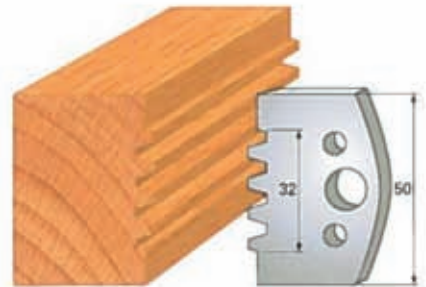

Art. SA2060 - (SA3060)

**STANDARD PROFILE KNIVES IN "SP" STEEL - height 50x4 mm  
(RELATING LIMITERS)**

**Example:  
Knife SA2..  
Limiter (SA3..)**

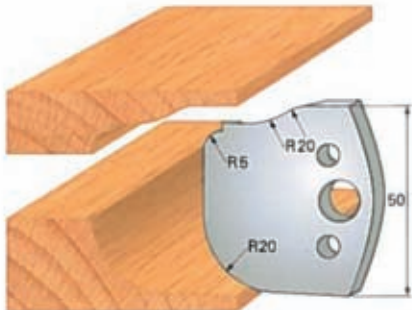

Art. SA2061 - (SA3061)

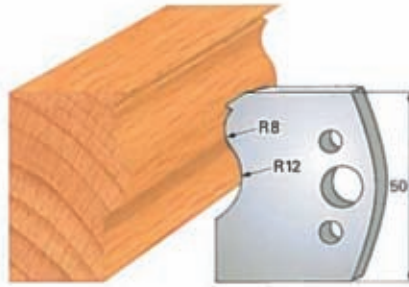

Art. SA2062 - (SA3062)

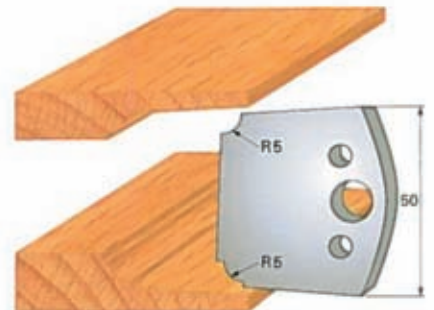

Art. SA2063 - (SA3063)

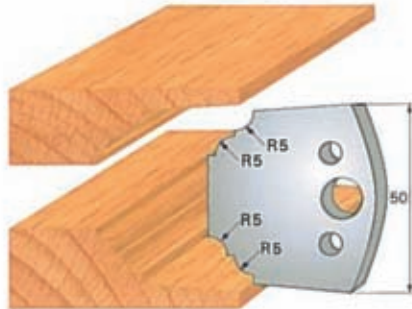

Art. SA2064 - (SA3064)